

DETERMINING APPROPRIATE DATA ANALYTICS FOR TRANSFORMER HEALTH MONITORING

Jose Ignacio Aizpurua, Victoria M. Catterson, Brian G. Stewart, Stephen D. J. McArthur

Institute for Energy and Environment, Department of Electronic and Electrical Engineering
University of Strathclyde
99 George Street, G1 1RD, Glasgow, UK
jose.aizpurua@strath.ac.uk; v.m.catterson@strath.ac.uk; brian.stewart.100@strath.ac.uk;
s.mcarthur@strath.ac.uk

Brandon Lambert, Bismark Ampofo

Bruce Power
Kincardine, Canada
Brandon.Lambert@brucepower.com
Bismark.Ampofo@brucepower.com

Gavin Pereira, James G. Cross

Kinectrics Inc.
Toronto, Canada
Gavin.Pereira@kinectrics.com
James.Cross@kinectrics.com

ABSTRACT

Transformers are vital assets for the safe, reliable and cost-effective operation of nuclear power plants. The unexpected failure of a transformer can lead to different consequences ranging from a lack of export capability, with the corresponding economic penalties, to catastrophic failure, with the associated health, safety and economic effects. Condition monitoring techniques examine the health of the transformer periodically, with the aim to identify early indicators of anomalies. However, many transformer failures occur because diagnostic and monitoring models do not identify degraded conditions in time. Therefore, health monitoring is an essential component to transformer lifecycle management. Existing tools for transformer health monitoring use traditional dissolved gas analysis based diagnostics techniques. With the advance of prognostics and health management (PHM) applications, we can enhance traditional transformer health monitoring techniques using PHM analytics. The design of an appropriate data analytics system requires a multi-stage design process including: (i) specification of engineering requirements; (ii) characterization of existing data sources and analytics to identify complementary techniques; (iii) development of the functional specification of the analytics suite to formalize its behavior, and finally (iv) deployment, validation, and verification of the functional requirements in the final platform. Accordingly, in this paper we propose a transformer analytics suite which incorporates anomaly detection, diagnostics, and prognostics modules in order to complement existing tools for transformer health monitoring.

Key Words: Data analytics, prognostics and health management, transformer, condition monitoring, insulation.

1 INTRODUCTION

The main goal of nuclear power plants (NPP) is the safe and reliable generation of electricity to support industrial, residential and commercial loads. Part of the generated electricity is also used for internal

operation purposes and therefore, the availability of electricity is a critical requirement in an NPP. Transformers are essential assets for the export and usage of electricity in an NPP. Accordingly, the correct and reliable operation of nuclear power plants is influenced by the performance of transformers. Although most transformers operate under the same principles [1], there are different types of transformers in an NPP. Focusing on CANDU NPP's, there are three types of transformers (see also Figure 1):

- *Main output transformers (MOT)* connect a generating station to the power network.
- *Unit service transformers (UST)* feed a portion of the generated power back to the station during normal operation.
- *Station service transformers (SST)* provide power from the grid to the station during shutdown and start-up. The SST will also operate as backup power supply to the UST during normal operation.

We can see in Figure 1 that the correct operation of transformers is critical to both export of electricity from the NPP to the grid (MOT) and to feed back part of the generated electricity for internal operation purposes (UST, SST). The consequences of unexpected transformer failures can range from economical penalties to health and safety issues caused by power outages and catastrophic failure respectively.

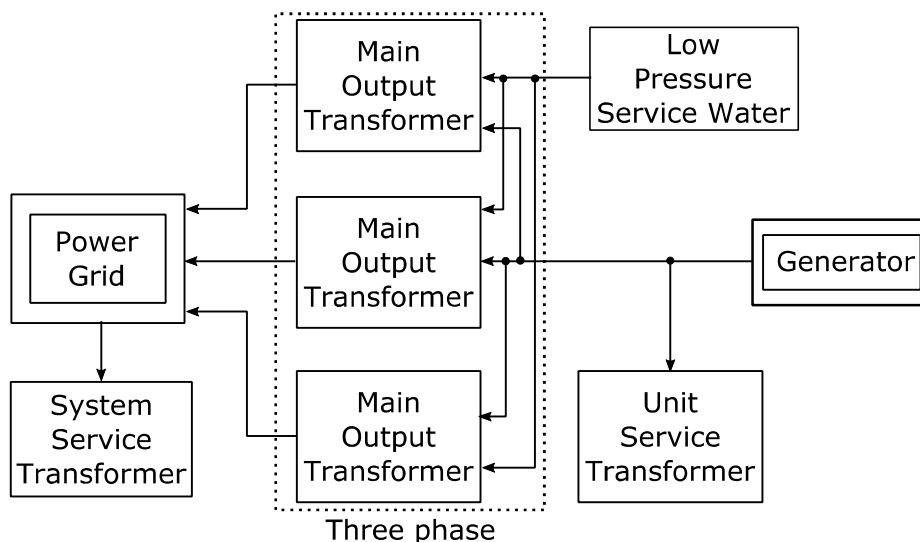

Figure 1. Example unit configuration.

Transformers are complex assets comprised of different subsystems such as bushings, core, tank, cooler, oil preservation system, load tap changer, winding, and protection system [1]. Each of these subsystems performs a specific function (e.g., the cooler controls the oil temperature; the tap-changer regulates the voltage) and collectively, they determine the performance and health of the transformer. These dependencies can be formally represented through a Fault Tree Analysis (FTA) model which represents the combination of subsystem failures that can cause transformer failure [2]. Figure 2 shows a simplified transformer FTA model, where transformer subsystems and contributing failure modes are identified [3]. For example, the winding assembly failure can be caused by the failure of the winding, connector, or the insulation system, and in turn, the winding failure can be caused by turn-turn, coil-coil, or coil-ground faults.

The correct operation of the transformer depends on the correct operation of multiple related components over a variety of conditions. When monitoring the transformer's health, the possible failure modes outlined in Figure 2 need to be examined. Traditional methods for transformer health assessment have been focused on the analysis of, e.g. gases dissolved in oil, temperature, or electrical parameters [1]. With the advance of prognostics and health management (PHM) applications, traditional transformer health

monitoring techniques can be enhanced with PHM analytics including anomaly detection, diagnostics, or prognostics analysis modules [4].

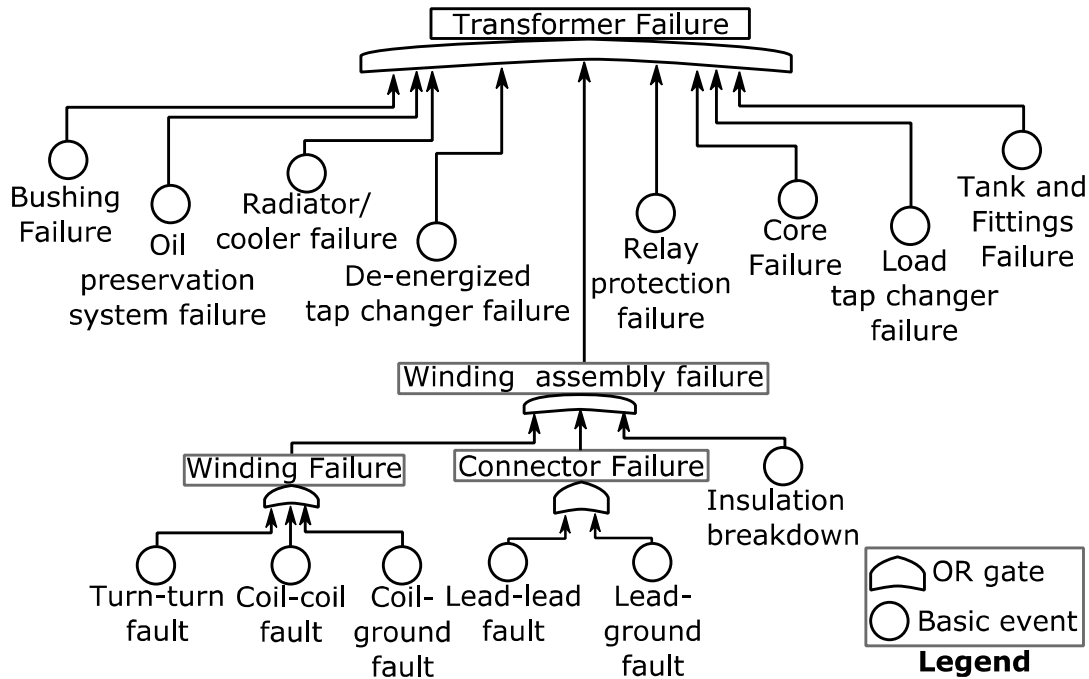

Figure 2. Simplified transformer Fault Tree model adapted from [3].

For industrial implementation purposes, the design of PHM analytics requires moving from ad-hoc algorithms towards the development of an analytic suite which takes into account industrial requirements. The main goal of this paper is thus the specification of appropriate analytics for lifecycle transformer health monitoring. These analytics will complement existing tools for transformer health monitoring and they will assist engineers in the asset management process within an NPP. The paper demonstrates the application of some of the analytics for transformer correlation and diagnosis analysis activities.

The paper is organized as follows. Section 2 describes the proposed analytics framework. Section 3 develops further some of these analytics. Finally, Section 4 draws conclusions and identifies future goals.

2 TRANSFORMER HEALTH MONITORING DATA ANALYTICS SUITE

The goal of the data analytics suite is to preemptively identify abnormal data patterns, determine the transformer's current health, forecast the service life, and predefine acceptance and action levels based on maintenance guidelines, industry experience, equipment health, and service conditions. The outcome of the analytic suite will be semi-automated decision support for preventive and reactive maintenance planning and input into life cycle management plans based on changing operational conditions and equipment health.

In order to address these goals and design an appropriate data analytics suite, we have followed a multi-stage design process including: (i) discussions with stakeholders to elicit engineering requirements; (ii) characterization of existing data sources and analytics to identify complementary techniques which will enhance the transformer health assessment; (iii) development of the analytics functional specification to formalize the behavior of the analytics suite, and finally (iv) deployment, validation, and verification of the functional requirements in the final platform. Figure 3 outlines the logical flow of the main analytic modules included in the transformer analytics suite.

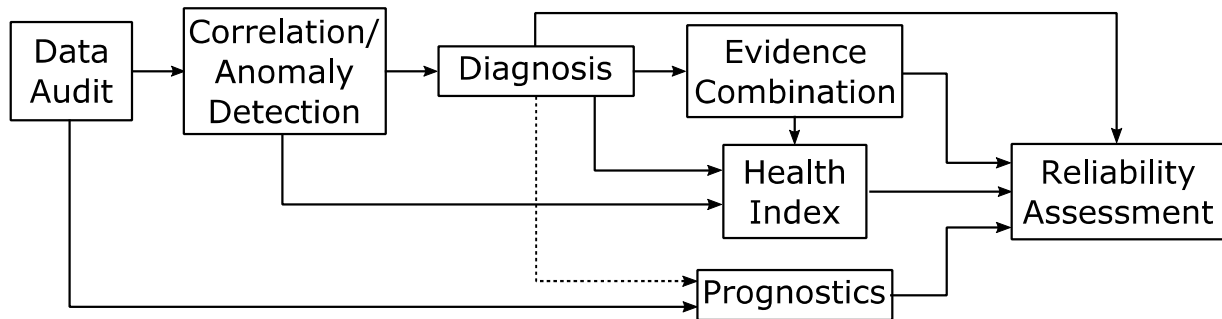
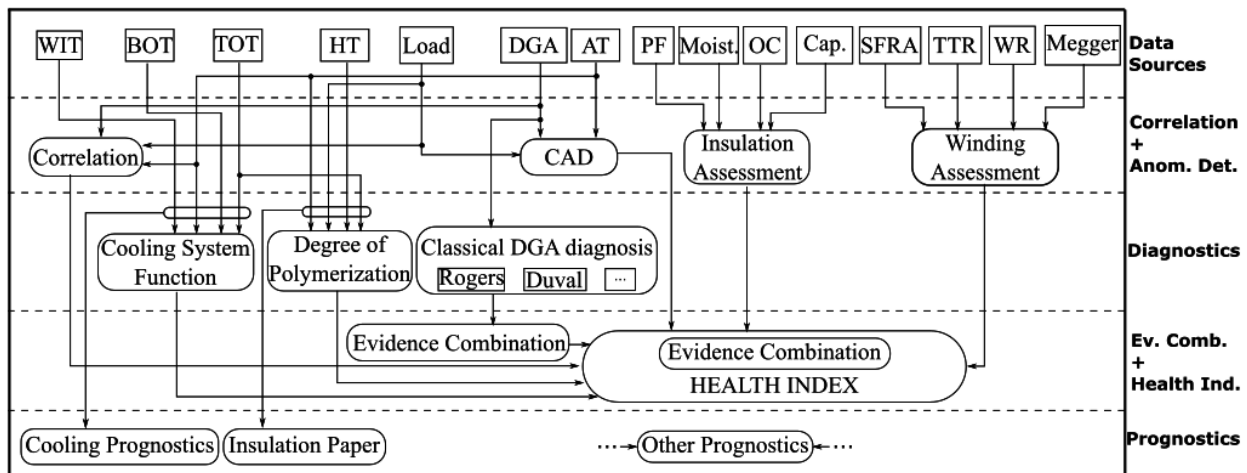

Figure 3. Health monitoring analytic modules.

The analytics framework design process starts from the *data audit* step: listing available datasets and identifying new variables that can be monitored to improve the health assessment process (Subsection 2.1). Next we model the *correlation and anomaly detection* so as to identify abnormal data patterns (Subsection 2.2). If an anomalous data trend is detected, then the *diagnostics* follows the process for the identification of failures (Subsection 2.3). The *evidence combination* aims to combine different diagnostics outcomes to generate an overall transformer diagnosis. Similarly, the *health index* generates an overall transformer health state indicator combining the information generated in all the previous activities (Subsection 2.4). After diagnosing the current health, we can estimate the remaining useful life through the application of future profiles (Subsection 2.5). The transformer *reliability assessment* can be performed through the FTA model in Figure 2 and it can be continuously updated through online PHM results generated from the data analytics [4].

Following the outlined PHM-oriented analytics design process, Figure 4 shows the proposed transformer data analytics suite.



Legend: *WIT*: water inlet temperature; *BOT*: bottom oil temperature, *TOT*: top-oil temperature, *HT*: hotspot temperature, *DGA*: dissolved gas analysis, *AT*: ambient temperature, *PF*: power factor, *Moist.*: moisture, *OC*: oil condition, *Cap.*: capacitance, *SFRA*: sweep frequency response analysis; *TTR*: transformer turns ratio, *WR*: winding resistance, *CAD*: conditional anomaly detection.

Figure 4. Transformer data analytics suite.

2.1 Data Sources

First we need to examine the critical parts of the transformer and if needed, install adequate sensing hardware components. If appropriate statistics are available [5], it is possible to analyze the criticality of

different parts of the transformer and rank components through importance measures [4]. For example, the insulation and winding are known to be critical parts of the transformer [1].

The key performance characteristics to be monitored in a transformer include: (i) dissolved gases in the oil, (ii) insulation-related parameters (power factor, moisture, capacitance, oil condition); (iii) oil temperatures and hottest spot temperature; (iv) winding parameters (tap-turns ratio, resistance, Megger test), and (v) external variables such as load or ambient temperature. We can classify these variables into two groups from the high-level point of view:

- *Operational and environmental data* that drive transformer behavior: load, ambient temperature, and water inlet temperature (in the case of water-cooled transformers).
- *Transformer condition-related data*: oil temperature, hottest spot temperature, dissolved gases, power factor, moisture, oil condition, capacitance, frequency response analysis, taps-turns ratio, winding resistance, and Megger test.

Transformer condition-related data can be further divided into off-line and on-line parameters, which may or may not require different analytics. Off-line parameter extraction requires the transformer to be de-energized whereas on-line data is sampled on an ongoing basis. Another important factor for the data audit process is the data management tool support. Some data samples may require tests in a laboratory and therefore the data collection and maintenance of test records becomes crucial.

2.2 Correlation and Anomaly Detection

There are interdependencies among different parts of the transformer, for instance the transformer load current is dependent on the generated power [1]; and the oil temperature is dependent on the ambient temperature [1]. Although the FTA model in Figure 2 shows disjoint failure modes among subsystems, it is possible to refine this model by taking into account correlations among transformer subsystems. However, these correlations are non-evident and they need to be determined on a case-by-case basis through data analysis and expert knowledge. Depending on the nature of the data it is possible to apply different correlation methods. Possible correlation implementations range from classical Spearman's correlations to more complex statistical methods such as copula analysis [6].

The sampling rate is crucial to correlating different variables. If variables are sampled with different schemes, it will be compulsory to apply signal processing methods to extract meaningful conclusions (e.g., downsampling, interpolating data samples). One specific example is the dissolved gas analysis (DGA) data. The sampling regime for DGA varies, but it is common to sample DGA annually, quarterly, or up to 6 times a year. If we are interested in correlating DGA samples with a more regularly sampled variable (e.g. hourly sampled load) an intermediate data processing module will be needed to avoid loss of information.

Anomaly detection focuses on the identification of abnormal patterns in the data. Normality patterns can be defined through different models that can learn to express the normal behavior of the system or asset under study [7]. Some systems are influenced by external factors, but many anomaly detection modules define the expected normality pattern solely based on condition-related data.

In this context one alternative is to implement a conditional anomaly detection (CAD) model [8] (Figure 5) which correlates transformer condition-related data and operational data. The goal is to distinguish situations where unusual operating conditions may be causing abnormal transformer behavior from situations where the transformer condition is unusual under normal operation. The latter case is more likely to represent a true deterioration of the transformer's health. To achieve this, Gaussian Mixture Models are used to generate multivariate statistical models that embed condition-related data within a transformer model, $P(Transf)$, and operating environment related data within an environment model, $P(Env)$. Then a correlation algorithm (Expectation Maximization) is used to generate a conditional probability model that correlates the environment and transformer models ($P(Transf|Env)$) [7].

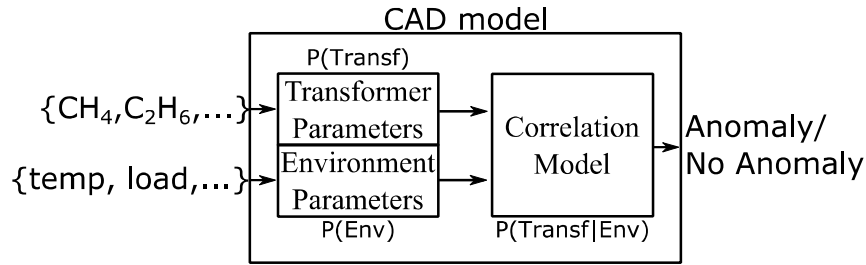

Figure 5. Conditional anomaly detection model.

The CAD module can take multiple different input variables to the transformer and environment models. For example, as shown in Figure 5 gas parameters can generate the transformer model (e.g., CH₄, C₂H₆) and temperature and load parameters the environment model. The CAD module will identify truly anomalous trends under normal operating conditions, and when combined with the diagnostics activity, it will reduce false alarms by triggering the diagnosis activity only if an anomaly has been identified.

2.3 Diagnostics

Diagnostics modeling depends on the specific subsystem under study. For instance, there are different types of cooling systems for transformers (e.g. Oil Natural Air Natural (ONAN) or Oil Directed Water Forced (ODWF)), and for each of these configurations, the cooling system is comprised of different components. A diagnostics model of paper insulation is introduced in Section 2.5, as a necessary step in developing a prognostics model of transformer paper's health.

Operational and fault events within the transformer generate gases which are dissolved in the insulating oil and DGA is a mature and industry-accepted method that focuses on the study of these gases. In order to aid in the rapid diagnosis of possible transformer faults, there have been proposed different ratio-based DGA techniques such as Doernenburg's ratios, Rogers' ratios, and Duval's triangle [9]. However, the accuracy of ratio-based DGA techniques may be limited for transformer fault classification because: (i) they use crisp decision bounds, (ii) they do not include uncertainty criteria in the fault classification; and (iii) the fault classification frameworks of each technique are different.

It is possible to improve the diagnosis accuracy of ratio-based DGA methods through the transformation of these techniques into a probabilistic diagnosis model through Bayesian networks [10]. To this end, first it is necessary to specify dependencies among the gases and failure modes in a directed acyclic graph. This information can be elicited from the ratio-based techniques that link gas ratios with failure modes (see Table I and Figure 6a, where R₁=CH₄/H₂, R₂=C₂H₂/C₂H₄, R₃=C₂H₂/CH₄, and R₄=C₂H₆/C₂H₂). Then the data must be discretized according to the ratio intervals defined for each technique. Table II displays discretized Doernenburg's ratios.

Table I. Doernenburg's classification ratios.

Diagnosis	R ₁	R ₂	R ₃	R ₄
Thermal	>1	<0.75	<0.3	>0.4
PD	<0.1	N/A	<0.3	>0.4
Arcing	0.1-1	>0.75	>0.3	<0.4

Table II. Discretized ratios.

Ratio	R ₁			R ₂		R ₃		R ₄	
Code	0	1	2	0	1	0	1	0	1
Range	≤1	0.1-1	>1	≤0.75	>0.75	≤0.3	>0.3	≤0.4	>0.4

The next step is to learn the conditional probabilities that link nodes with edges, and finally to implement inference algorithms to estimate the likelihood of failure modes given gas observations (see Figure 6b). This framework can be expected to effectively improve the diagnosis accuracy of ratio-based techniques by treating the classification criteria through conditional probability models and estimating the likelihood for the occurrence of each failure mode given the gas observations.

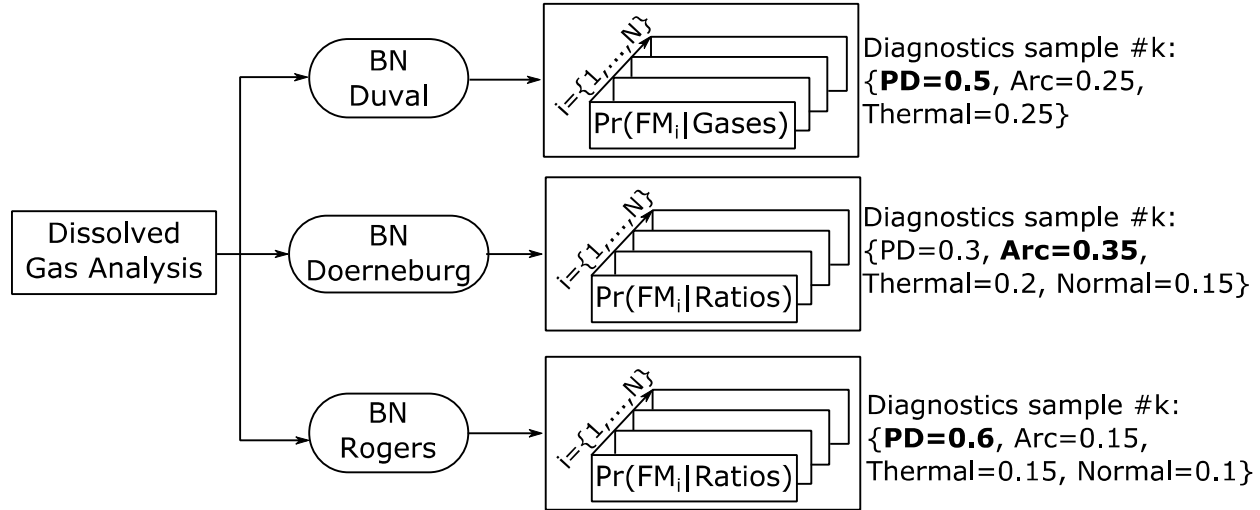

Figure 6. Bayesian networks for DGA: (a) Doernenburg's model (b) overall framework.

2.4 Evidence Combination and Health Index

When different PHM techniques examine the same failure mode (e.g. DGA based transformer diagnosis), their outcomes may be different because they use different algorithms. The evidence combination activity [11] handles inconsistencies among input modules and generates a consistent output.

For instance, evidence combination may be used to combine different ratio-based DGA diagnostics outputs (Duval, Rogers, Doernenburg) to generate consistent diagnostics. Evidence combination techniques range from majority voting to other applications using artificial intelligence or sensor fusion concepts [11]. So as to obtain a more accurate overall classification, diversity among classifier models is a critical requirement. The same evidence combination process can also be applied to prognostics models.

The health index (HI) integrates all the available transformer PHM analytic modules into an overall condition evaluation model. The HI aids in the maintenance decision-making process through mapping HI values with needed maintenance actions [12]. To this end, the health state of independent subsystems needs to be combined to generate a final overall HI which represents the transformer's health. This combination can be done through weighted algorithms, expert knowledge, or evidential reasoning techniques, e.g. [12].

All the generated analytics may be connected with the HI module, however, an interpretation function will be needed to parse them and generate a unique HI. The output will be a numeric value which will quantify the transformer's health. Let us denote for the failure mode i the remaining useful life, RUL_i , the health, H_i , and the conditional anomaly detection outcome, CAD_i . Then the HI can be defined as:

$$HI = (RUL_i, H_i, CAD_i), 1 < i < |FM| \quad (1)$$

where $|FM|$ denotes the total number of failure modes and \cdot denotes the HI combination function. RUL_i and H_i may be specified as probability density functions and CAD_i can be expressed as an indicator signal (failure occurring or not occurring) with its corresponding probabilistic weight.

2.5 Prognostics

Prognostics techniques are used to predict the remaining useful life (RUL) of the asset under study [13]. These techniques can be classified into data-driven, model-based and hybrid approaches and depending on the available engineering resources (run-to-failure data, knowledge of physics-of-failure equations), the designer can decide which is the best suited algorithm [13]. Namely, when run-to-failure data or knowledge of the system's physics-of-failure equation is available, data-driven or model-based approaches are selected, respectively. When both engineering resources are available, the selection of the high-level group incurs a trade-off decision between the availability of statistically significant run-to-failure data and complexity of the degradation equation. If the complexity is manageable and there is enough run-to-failure data, hybrid prognostics techniques can be selected.

Focusing on transformer insulation paper prognostics, it is possible to model a physics-of-failure based prognostics prediction model [14]. The life of the transformer insulation can be quantified by the degree of polymerization (DP) of the insulating paper. The rate of aging of the paper is primarily determined by temperature. Aging is most rapid at the transformer hottest spot and the paper here will have the lowest DP of the transformer [15]. New paper has a DP approximately in the range of 1000-1200, while end of life is generally considered to be 200 [15]. A model of paper aging is given in IEEE C57.91 [15]. This assumes a life of 150000 hours at a temperature of 110°C for a standard transformer to reach a DP of 200. The standard defines an aging accelerator factor F_{AA} as follows,

$$F_{AA} = e^{\frac{15000}{383} - \frac{15000}{273 + \theta_H}} \quad (2)$$

where θ_H is the hottest spot temperature. Alternatively, if the hottest spot temperature is not directly available, it can be inferred from other variables:

$$\theta_H = \theta_{to} + \left(80 - \Delta\theta_{\frac{to}{a,R}}\right) \times K^{2m} \quad (3)$$

where θ_{to} is the measured top oil temperature, $\theta_{to/a,R}$ is the difference in the temperature between top oil and ambient at rated current, K is the ratio of the measured load to rated load, and m is a constant related to the cooling model of the transformer.

This model takes as input (i) hottest spot temperature, or (ii) load, top oil and ambient temperature, and generates the aging acceleration factor. This factor determines the consumed paper life and current health state. Future operation profiles (e.g. load) can be used to predict the RUL of the insulation paper.

3 ANALYTIC SUITE APPLICATION EXAMPLES

3.1 Conditional Anomaly Detection

Development of the CAD model requires a training environment and transformer models and then generating a correlation model. In this case, as an illustrative example, we have used the generated power and ambient temperature in an environmental model, and methane (CH₄) and hydrogen (H₂) for the transformer model. We have trained both models based on normal data (20 samples), which is determined by a period of stable gas levels, and the rest of data is used for testing (20 samples). Figure 7a shows the trained environment model where the axes in the horizontal plane denote normalized training values of true power and temperature and the vertical axis identifies their joint probability density, e.g. when the true power is very high it is likely that the temperature will be low. Figure 7b shows the trained transformer model where horizontal plane axes denote methane and hydrogen, and the vertical axis denotes the probability density, e.g. it is very likely that when hydrogen is small methane is small too. These figures model the expected independent normal behavior of the transformer and environment.

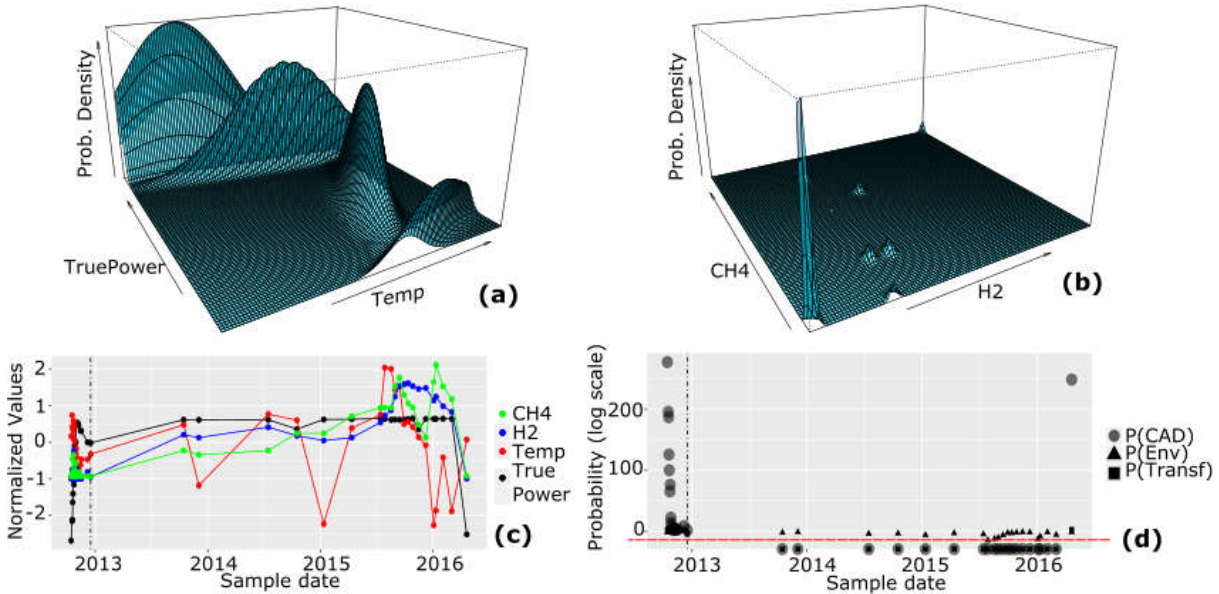

Figure 7. (a) Trained environment model (b) transformer model (c) train-test datasets (d) CAD results.

After learning the environment and transformer models, we test the correlation model. Figure 7c shows the normalized test data and Figure 7d shows the CAD outcome, where the red horizontal line identifies the failure threshold and the vertical dashed line indicates the division between training and testing data. We can see in Figure 7d that almost all the test data is classified as anomalous, because the environment probability is high (triangles above the red line: normal environment) but the transformer model's probability is low (squares below the red line), which indicates a true anomaly (circles below the red line). Note also that the last sample is classified as healthy (circle in the top right) because both transformer and environment models match with the trained models (Figures 7a and 7b).

In this particular case, the gas levels from the test period were known to be significantly different from those during the training period. This resulted from a scheduled change in operation of the cooling of the transformer, and the gassing behavior was being carefully monitored. Therefore, this case shows the power of the CAD technique to recognize anomalous behavior.

3.2 Diagnosis

The implementation of the diagnosis model introduced in Subsection 2.3 requires a supervised learning approach with labeled gas samples identifying known failure modes. A well-known dataset is the IEC TC 10 dataset [16], where a large collection of transformer gas samples are stored with the corresponding failure mode. If we focus on Doernenburg's ratio method, first we need to discretize the dataset according to the ratios and intervals defined by the method (Tables I and II).

The next step is to train the Bayesian network model shown in Figure 6b with the training dataset. We train the Bayesian network model using the maximum likelihood estimation algorithm. The learned conditional probabilities will include the likelihood for each node given its dependent nodes. After the learning phase, we can make inferences to test the accuracy of the classifier. For example, if we observe gas values which correspond to these ratios $R_1=0.14$, $R_2=6.1$, $R_3=5.3$, $R_4=0.014$, we discretize these values ($R_1=1$, $R_2=1$, $R_3=1$, $R_4=0$) and then make inferences with the Bayesian network for each of the failure modes: $Pr(PD|R_1, R_2, R_3, R_4)=0.005$; $Pr(Arcing|R_1, R_2, R_3, R_4)=0.92$; $Pr(Thermal|R_1, R_2, R_3, R_4)=0.075$; which lead us to the correct conclusion that the fault was caused by the arcing type of fault.

3.3 Prognostics

Equations (2) and (3) can be used to implement a prognostics model and predict the RUL of the transformer paper by applying likely future load scenarios [14]. The particle filtering method provides a suitable framework to implement this concept, which takes as input transformer load, ambient temperature, and top oil temperature; and estimates transformer paper RUL at time t , RUL_t [14]:

$$RUL_t = RUL_{t-1} - F_{AA}(\theta_{to}, \theta_{to/a,R}, K, m) + \mu_t \quad (4)$$

where F_{AA} is the aging acceleration factor (as defined Subsection 2.5), and μ_t is the process noise which models the variation in the lifetime reduction for a given hottest spot temperature.

Figure 8a shows three hypothetical future load scenarios applied to the model in Equation (3). Figure 8b shows the corresponding RUL density functions estimated through Particle filtering, where the x axis denotes the RUL in hours and the y axis denotes the probability density. For example, in case 1 the RUL with maximum likelihood is 149994 hours, whereas in case 3 the RUL is 149844 hours, i.e. the more load applied to the transformer, the more rapidly the transformer paper ages.

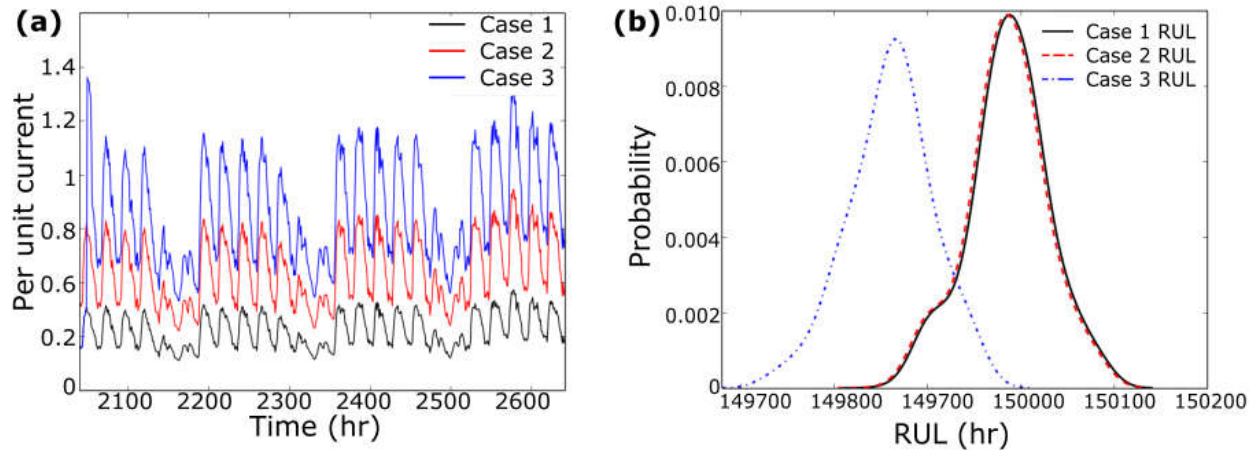

Figure 8. (a) Transformer loads (b) RUL predictions for different loads [14].

4 CONCLUSIONS

This paper presents a novel data analytics framework for transformer health monitoring based on prognostics and health management methods. The proposed analytics suite includes correlation, conditional anomaly detection, diagnostics, evidence combination, health index estimation and prognostics modules. Anomaly detection, diagnosis and prognostics prediction examples have been shown to illustrate the applicability of the proposed framework. As a consequence, the analytic suite can assist maintenance engineers in the transformer lifecycle management process through the identification of early malfunction indicators and estimation of the influence of future operational conditions on transformer health.

Future goals will focus on implementing the proposed analytics framework through prototyping of different analytic modules and generating useful technical outcomes for maintenance scheduling.

5 REFERENCES

1. M. J. Heathcote, *J & P Transformer Book (Thirteenth Edition)*, Elsevier, Oxford, UK (2007).
2. W. E. Vesely, M. Stamatelatos, J. B. Dugan, J. Fragola, J. Minarick, and J. Railsback, "Fault tree handbook with aerospace applications," NASA Office of Safety and Mission Assurance (2002).

3. IEEE, "IEEE Guide for the Evaluation and Reconditioning of Liquid Immersed Power Transformers," IEEE Std C57.140-2006, New York, April (2007).
4. J. I. Aizpurua and C. Victoria, "ADEPS: A Methodology for Designing Prognostic Applications," *Proceedings of European PHM Society Conference*, Bilbao, Spain, June 2016, Vol. 7, p. 14, (2016)
5. "Transformer Reliability Survey," CIGRÉ, No 642, (2015).
6. G. Papaefthymiou and D. Kurowicka, "Using Copulas for Modeling Stochastic Dependence in Power System Uncertainty Analysis," *IEEE Transactions on Power Systems*, **24**, pp. 40-49 (2009).
7. V. M. Catterson, S. D. J. McArthur, and G. Moss, "Online Conditional Anomaly Detection in Multivariate Data for Transformer Monitoring," *IEEE Trans. Power Del.*, **25**, pp. 2556-2564 (2010).
8. X. Song, M. Wu, C. Jermaine, and S. Ranka, "Conditional Anomaly Detection," *IEEE Transactions on Knowledge and Data Engineering*, vol. 19, pp. 631-645, 2007.
9. IEEE, "IEEE Guide for the Interpretation of Gases Generated in Oil-Immersed Transformers," IEEE Std C57.104-2008, February (2009).
10. W. H. Tang, Z. Lu, and Q. H. Wu, "A Bayesian network approach to power system asset management for transformer dissolved gas analysis," *Proceedings of DRPT*, China, 2008, pp. 1460-1466 (2008).
11. V. M. Catterson and S. D. J. McArthur, "Using evidence combination for transformer defect diagnosis," *International Journal of Innovations in Energy Systems and Power*, **1**, pp 8-12, (2006).
12. A. Jahromi, R. Piercy, S. Cress, J. Service, and W. Fan, "An approach to power transformer asset management using health index," *IEEE Electrical Insulation Magazine*, **25**, pp. 20-34 (2009).
13. J. I. Aizpurua and V. M. Catterson, "Towards a methodology for design of prognostics systems," *Proceedings of PHM Society Conference*, San Diego, CA, October 2015, vol. 6, p. 14 (2015).
14. V. M. Catterson, J. Melone, and M. S. Garcia, "Prognostics of transformer paper insulation using statistical particle filtering of on-line data," *IEEE Electrical Insulation Magazine*, **32**, pp. 28-33, (2016).
15. IEEE, "IEEE Guide for Loading Mineral-Oil-Immersed Transformers and Step-Voltage Regulators," IEEE Std C57.91-2011, New York, March (2012).
16. M. Duval and A. dePablo, "Interpretation of gas-in-oil analysis using new IEC publication 60599 and IEC TC 10 databases," *IEEE Electrical Insulation Magazine*, **17**, pp. 31-41 (2001).